



PRODUCT
CATALOGUE 2024

**History &
Features**



**10
Window
Cleaning**



**28
Soft
Washing**



**32
Roof
Cleaning**



**36
Waterfed
Poles**

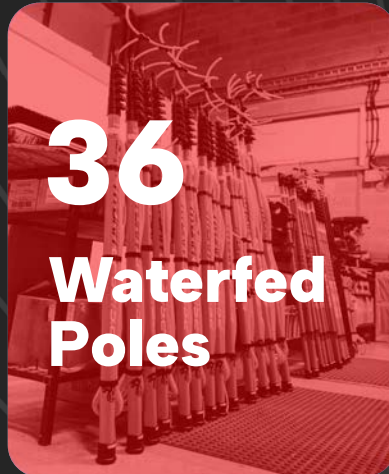

**38
Hose
Reels
&
Gutter
Cleaning**



About Us

The company that changed the window cleaning industry.

For 12 years we were expert window cleaners, and for the past 25 years we've continued to draw on that expertise to deliver ground breaking Reach & Wash® products that make window cleaning safer, faster and more profitable for our customers. **This is why we remain No.1 in the market.**

The Reach & Wash® logo depicts an athletic figure created from water using a waterfed pole for cleaning. The logo reminds us that it is actually the water that is doing the work.

Once you understand that, then like us you'll realise the purer the water the faster and better the cleaning results will be. Uniquely, Ionic offers the very best water quality out of all competing products.

However, it's no longer just window cleaning that we have become specialised in. We now offer a range of Soft Washing and Roof Cleaning systems, namely the Foamion® and Roof Wand®.

No matter what we create, we apply the same Ionic ethos to all of our products.



Quality. Safety. Efficiency.

If a product doesn't match these values, it is not an Ionic Systems Reach & Wash® product.

For more information, videos and technical specifications please visit our website ionicsystems.com or scan the various QR codes located within this catalogue.



Through the years...

We've hit many milestones and released many bestsellers over the years, have a look at some of our proudest moments.



1997

Over The Top (OTT) invents the Reach & Wash™ system and the British Window Cleaning Academy (BWCA) is launched.



2002

Ionic launches the 'Thermopure'. The very first hot water Reach & Wash™ system. It quickly won the approval of window cleaners, fast becoming one of our most popular systems.

2005

New UK regulations severely restrict the use of ladders, causing unprecedented numbers of window cleaners to convert to the Reach & Wash™ system.

1998

OTT pioneers the use of waterfed poles and pure water for window cleaning.

2001

'Over the Top Ltd' changes its name to 'Ionic Systems Ltd, reflecting the change in focus of the business.

2003

Ionic launches the 'ERGOLITE' range of waterfed poles, developed to be lighter, more rigid and narrower in response to new HSL recommendations.

2006

Ionic develop and release the Pro-6 system. Reducing water consumption by 50%, the Pro-6 is one of the finest window cleaning systems available.

This was also the year we completed full crash testing of our van mounted systems. We remain to be one of the only suppliers to achieve the FMVSS-208 safety standard.



2012

Zero™ by Ionic Systems is launched. With fully automated flushing and regen cycle, 8-stage filtration and 18 meg-ohm water at OPPB - the Zero™ is the simply the best system available.



2014

Ionic moves into a brand new 22,000 sq ft building, suited for the increased level of production to meet demand.

2021

Ionic has developed and released the Roof Wand™, the safest and most effective method of cleaning a roof, utilising the same concept as the Reach & Wash™ system.



2023

Ionic continues to innovate, with the release of the Foamion Portable, unveiled at the London Cleaning Show 2023.

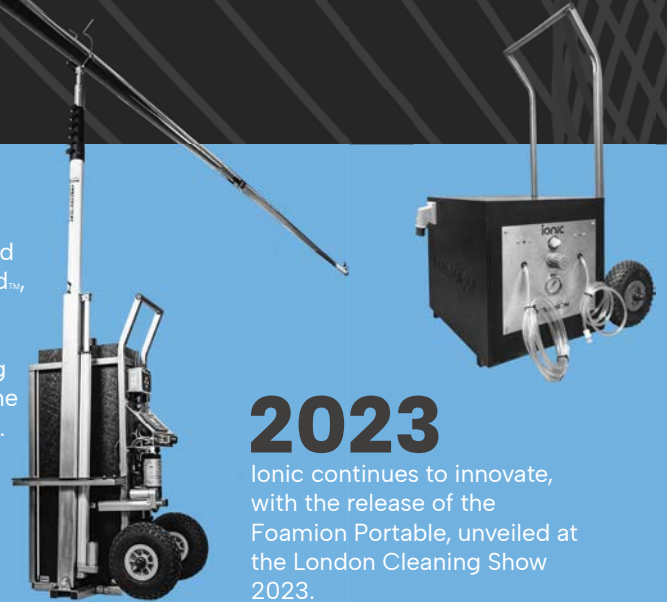

2009

'TRANSVERSE' clamps are fitted to Ionic poles. They are smaller, lighter and grip the poles more evenly. The 'GLYDER' pole was released a year later.



2020

Ionic Systems release the Foamion™ Softwashing system as an extension unit for a pre-existing Reach & Wash™ system. Foamion™ makes it easier for window cleaners to diversify and expand their business.



2022

Ionic celebrates its 25th year of business and continues to innovate and push the market. Following the years after the COVID-19 pandemic, Ionic Systems remains a market leader due to its ability to proactively adapt and respond to the industry.

2024

Ionic releases the long-awaited and game changing 'Endura' anti-rotational waterfed pole. This is the first true anti-rotational pole design that retain the original circular tube shape.

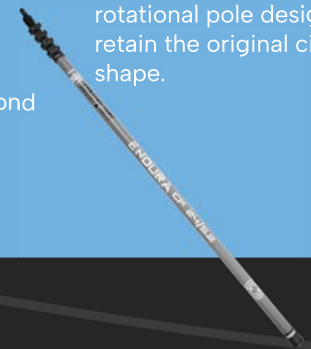



Professional training for you and your employees.



Roof Cleaning

The BWCA's newest course focuses on a revolutionary new way of cleaning roofs from the safety of the ground.



Soft Washing

The BWCA's Soft Washing Course is ideal for anyone either with or without experience looking to enter the Soft Wash market.

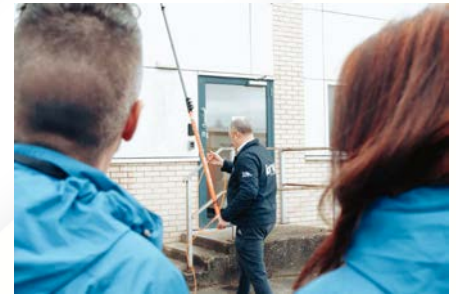

Window Cleaning

Waterfed Poles is our most popular course, and is appropriate for window cleaners at all levels who use (or plan to use) waterfed poles.

20%
OFF DISCOUNT

Purchase 2 or more courses to apply a 20% discount!

Visit our website for more information.

bwca.co.uk

Safety: Our Core Commitment

At Ionic, we are unwavering in our commitment to ensuring the highest levels of safety for our customers. We understand that trust is the cornerstone of our relationship with you. This is why safety isn't just a feature of our products; it's the foundation of everything we do. From rigorous crash testing, to achieving top safety ratings and innovating with electrical safety features like insulated pole handles, our dedication to safety is all-encompassing.



Innovating for Electrical Safety

Despite the best efforts of the window industry to warn window cleaners about the risk of electrocution too many have lost lives or suffered serious burns whilst using waterfed poles near overhead power lines of under 1,000volts. Ionic Systems is the first company to have addressed road safety, and now Ionic Systems is the only manufacturer to have developed a waterfed protector pole to address the risk of electrocution.



Unparalleled Crash Testing

Following these tests and the chassis design and installation changes that resulted, 100% impact barrier tests at 31.1mph were conducted as required for FMVSS-208 certification.

Our Promise to You

Ionic's commitment to safety is unwavering. It's not just about meeting safety standards; it's about setting new benchmarks for safety in the industry. We pledge to continue innovating and investing in safety technologies that protect our customers, and enhance their confidence in our products. With Ionic, you can rest assured that safety is always our top priority.

Features

Take a look at the features that make an Ionic system the best available on the market.



Automation

We have a range of patented automation technologies specifically designed to make the functioning of our systems as seamless as possible.

ROMS™

Reverse Osmosis Maintenance System.

At the end of each tank fill, pure water is diverted to the RO membrane, leaving it bathed in pure water rather than high TDS tap water.

PFS™

Periodic Flush System

On start up, this feature automatically flushes the reverse osmosis membrane for 2 minutes. Thereafter, the RO is flushed for 2 minutes every hour during the filling process.



Stainless Steel Construction

All of our machines are built using high quality stainless steel. We use this material because it is non-corrosive, meaning it will never rust, and is extremely robust.



Aftersales Care & Training

We are one of the only exterior cleaning systems manufacturers to offer complete aftersales support & training.

Partnered with the BWCA, we provide extensive training on the use of our products, as well as teaching customers how to successfully grow their business.



Vehicle Accessories

Choosing the right vehicle and customising it to your businesses needs is very important. Read below for some useful information to consider when choosing a vehicle.



Vehicle floor protection

We highly recommend our vehicle floor protection services to all of our customers. We apply a hard wearing, waterproof lining that protects your vehicle from rust, damage and water ingress.

Lining is applied to the vehicle floor and lower section of the sides for maximum protection. Water simply runs off without ever coming into contact with the paintwork.

Small Vans	£700
Medium Vans	£800
Large Vans	£900



Charging options

We also highly recommend purchasing an on-board battery charger for your system. This battery charger will enable automatic charging of the system's leisure battery through the driving of your vehicle.

Modern "stop-start" vehicles will need a "battery-to-battery" charger, whilst older vehicles generally use a "split charger".

Vehicle Payloads

Your choice of vehicle will dictate what cleaning system you will be able to carry. Here we have created a table to show you what payload of vehicle will be necessary depending on the size tank system you purchase.

300L	400L	500L	600L	700L	800L	900L	1000L
600kg	700kg	1000kg	1100kg	1200kg	1300kg	1400kg	1500kg

300L & 400L systems payload is based on the van having a single operator, 1 hose reel & pole.
500L systems & larger payload is based on twin operatives, 2 hose reels & selection of poles.

Pole racks

Stainless steel pole racks can be fitted to your finished vehicle. These provide a sturdy and professional looking storage for your waterfed poles.



Roof Mount (Low Roof)	£200
Roof Mount (High Roof)	£250
Side Mount	£125

Water Ports

Don't want to leave your van open when filling or operating your system? Our stainless steel water ports allow for seamless use. Up to 3 connectors using ½ inch or John Guest fittings.

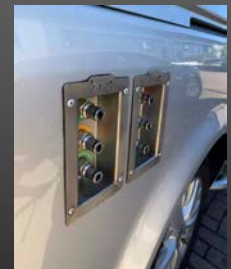

PPB ZERO

The Zero™ system represents the ultimate in pure water window cleaning systems.

It was back in 1997 that Ionic Systems introduced The Reach & Wash® System. We told the world of window cleaning that water of zero parts per million (0ppm) was the standard required for spot free results. Yet in truth waterfed poles are not magic wands, and both cleaners and customers alike sometimes experience windows left with less than perfect results.

Fifteen years later Ionic's new 'Zero' produces ultra pure water at zero parts per billion (0ppb), and that represents the gold standard. Water at 0ppb is 1,000 times purer than water at 0ppm, and because pure water cleans by dissolving dirt ions, it follows that water at 0ppb is capable of dissolving 1,000 times more dirt than water of 0ppm.

Other systems remove only dissolved solids from the water supply, uniquely the Zero® removes both dissolved solids and all organics, as well as bacteria from the water supply. The result is not only water that is 1,000 times purer but also ultra pure water that is free from micro-organisms such as legionella bacteria and the organic matter that bacteria feeds upon. A significant benefit is that biofilm cannot form upon the surface of filter media, or the RO membrane. That means that filters maintain day one performance, which in turn means lower running costs.

Cleaning with 18meg-ohm (0PPB) water is a breeze, powering through years of baked on dirt and the dulling effects of pollution on glass. Whether its an initial clean, or a reduced frequency clean, the Zero™ is the system of choice to deliver spot free results in the shortest time.



Scan the QR Code for
more information about
the Zero and 0PPB water!



Features

Take a look at the features that make the Zero™ system the best available on the market.



8-Stage Filtration



Delonisation



Reverse Osmosis **x2**



5µm Sediment Filter **x2**



Carbon Filter



NGDI Filter



UV + Ozone Filter

Heated Water

The Thermopure™ upgrade enables the use of heated water.

Digital Flow Control

Auto-compensating digital flow control allows precise operation of the pumps.

Dual TDS Monitoring

The TDS of the water at critical stages is monitored.

230v Boosted Fill

A standard feature on all Ionic machines. Allows for significantly faster filling.

Twin Pumps

The Zero™ has two independently controlled pumps allowing more than one pole to be used at the same time.

Easy Refillable Filters

The filter media cartridge is simply replaced when spent.

150 Ah Battery

The Zero is powered by a high capacity lead acid battery. Lithium ion battery is optional.

Stainless Steel Chassis

Like all Ionic cleaning systems, this model is built with a stainless steel, non-corroding, ever lasting chassis. Comes with a 10-year warranty.

Fully Automated Flush Cycle

The Zero™ has fully automated PFS™, & ROMS™ features that allow you to simply connect your mains water to the system at the end of the day and the system will take care of the rest.

Zero™

The Zero™ represents the very best system for your window cleaning business. (Pure water production up to 6 litre's per min dependent upon mains water supply). Complete with fully baffled black polypropylene tank and stainless steel construction for full vehicle stability. Includes temperature & tank sight gauge, as well as integrated battery charger.

Prices & Finance

Zero parts per Billion	Machine Only	3-Year Finance	5-Year Finance
Zero™ PPB System 500 Litre	£9,700	£350	£233
Zero™ PPB System 600 Litre	£9,800	£353	£235
Zero™ PPB System 700 Litre	£9,900	£357	£238
Zero™ PPB System 800 Litre	£10,200	£368	£245
Zero™ PPB System 900 Litre	£10,300	£370	£247
Zero™ PPB System 1,000 Litre	£10,400	£375	£250

Upgrades

Thermopure	+£4,000	+£144	+£96
------------	---------	-------	------

Finance prices are Per Calendar Month

Zero™ 'S'

All the features of the Zero™.

However, the 'S' model also features our high performance stainless steel filter housings to turbo charge pure water production. The 'S' model is highly recommended for use in countries where summer temperature's rise above 35 degrees C.

Prices & Finance

Zero parts per Billion	Machine Only	3-Year Finance	5-Year Finance
Zero™'S' PPB System 500 Litre	£10,100	£364	£242
Zero™'S' PPB System 600 Litre	£10,200	£367	£245
Zero™'S' PPB System 700 Litre	£10,300	£371	£247
Zero™'S' PPB System 800 Litre	£10,600	£382	£255
Zero™'S' PPB System 900 Litre	£10,700	£385	£257
Zero™'S' PPB System 1,000 Litre	£10,800	£389	£260

Upgrades

Thermopure	+£4,000	+£144	+£96
------------	---------	-------	------

Finance prices are Per Calendar Month

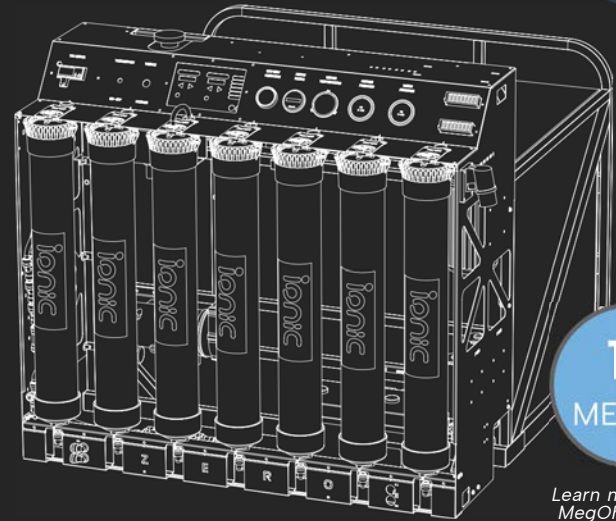

18
MEGΩ

Learn more about
MegOhm on our
website!

Dimensions (mm):

500L, 600L & 700L = H 1065 x W 1224 x D 1300
800L, 900L & 1000L = H 1065 x W 1224 x D 1450

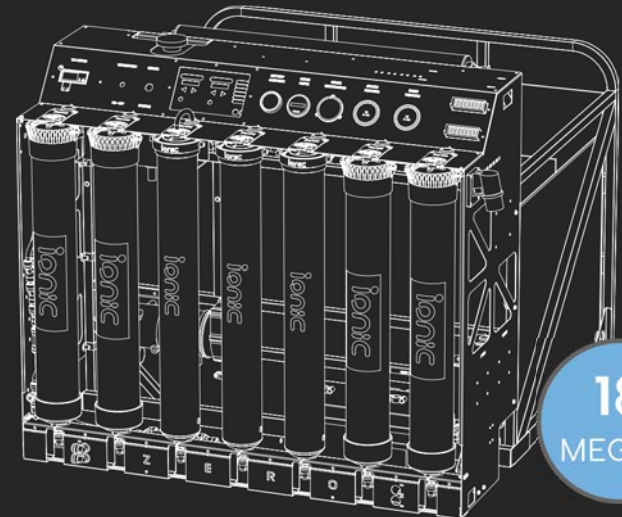

18
MEGΩ

Dimensions (mm):

500L, 600L & 700L = H 1065 x W 1224 x D 1300
800L, 900L & 1000L = H 1065 x W 1224 x D 1450

V4

The V4™ Thermopure fills the gap between the Zero™ with OPPB water quality and Ionic's cold water V4™.

The name V4™ signifies version four of the original Reach & Wash® system, and previously if you wanted hot water then your only option was to run a HotBox™ alongside.

Now rolled into one great looking, space saving package the V4 Thermopure™ has the look of the more expensive Zero™, but with a lower price tag.

The all stainless steel construction will remain corrosion free, outlasting your vehicles many times over. A crash tested Ionic system will last the whole of your window cleaning career, and prove to be by far the most cost effective choice. Just like the standard V4™ the Thermopure™ version can be configured with boosted fill, and a range of automation features to suit your individual needs and price point.

V4 Thermopure is technically superior in many ways too. The 9 kilowatt diesel powered water heater draws its fuel

from the vehicles own fuel tank. Purified water produced by the industrial sized water filters stored in the perfectly baffled holding tank can either be heated on demand, or can be heated more economically by preheating the pure water prior to use. As well as reducing fuel consumption preheating also comes with the benefit of preventing winter frost damage to system components and a frost free windscreen!

The system cleverly optimises performance of the diesel heater, by avoiding cycling constant temperatures are maintained on both the summer and winter settings.

Provided the instructions are followed, many years of service can be expected. Many of our early Thermopure™ customers are still operating their original machines today, opting to move their machine into their next van!

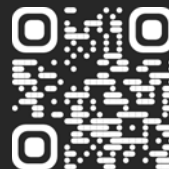

Scan the QR Code for more information!



Features

Take a look at the features of the V4™ Hot and Cold water systems.



Pictured above:
V4 Thermopure™ hot water system.

4-Stage Filtration



Deionisation



Reverse Osmosis



5-Micron Filtration



Carbon Filter

Easy Refillable Filters

The filter media cartridge is simply replaced when spent.

Dual TDS Monitoring

The TDS of the water at critical stages is monitored.

Twin Pumps

Two independently controlled pumps allowing more than one pole to be used at the same time.

Fully Automated Flush Cycle

The V4™ has fully automated PFS™, & ROMS™ features that allow you to simply connect your mains water to the system at the end of the day and the system will take care of the rest.

Stainless Steel Chassis

Like all Ionic cleaning systems, this model is built with a stainless steel, non-corroding, ever lasting chassis. Comes with a 10-year warranty.

Digital Flow Control

Auto-compensating digital flow control allows precise operation of the pumps.

230v Boosted Fill

A standard feature on all Ionic machines. Allows for significantly faster filling.

100Ah (Cold) & 150Ah (Hot) Battery

Powered by a high capacity lead acid battery. Lithium ion battery is optional.

V4 Fusion™

FUSION™ is a high performance, fully automatic four-stage RO/DI system with 240v mains powered boosted fill. PFS™ & ROMS™ are all standard features on the Ionic FUSION™ System. (Pure water production up to 3 ltrs per min dependent upon mains water supply). System includes integrated mains battery charger, tank sight gauge and a fully baffled water tank.

Prices & Finance

		Machine Only	3-Year Finance	5-Year Finance
V4™Fusion	300 Litre	£6,400	£231	£154
V4™Fusion	400 Litre	£6,500	£234	£156
V4™Fusion	500 Litre	£6,800	£245	£164
V4™Fusion	600 Litre	£6,900	£249	£166
V4™Fusion	700 Litre	£7,000	£252	£168
V4™Fusion	800 Litre	£7,300	£263	£176
V4™Fusion	900 Litre	£7,400	£267	£178
V4™Fusion	1,000 Litre	£7,500	£270	£180

Finance prices are Per Calendar Month

V4 Fusion™ 'S'

FUSION 'S'™ is an ultra high performance system designed for the most demanding customers, as well as the world's hottest climates. With fully automatic four-stage RO/DI system with 240v mains powered boosted fill. PFS™ & ROMS™ and of course stainless steel filter housings, all standard features on the Ionic FUSION 'S'™ System. (Pure water production up to 5 ltrs per min dependent upon mains water supply).

Prices & Finance

		Machine Only	3-Year Finance	5-Year Finance
V4™Fusion 'S'	300 Litre	£7,200	£260	£173
V4™Fusion 'S'	400 Litre	£7,300	£263	£176
V4™Fusion 'S'	500 Litre	£7,600	£274	£183
V4™Fusion 'S'	600 Litre	£7,700	£278	£185
V4™Fusion 'S'	700 Litre	£7,800	£281	£188
V4™Fusion 'S'	800 Litre	£8,100	£292	£195
V4™Fusion 'S'	900 Litre	£8,200	£296	£197
V4™Fusion 'S'	1,000 Litre	£8,300	£299	£200

Finance prices are Per Calendar Month

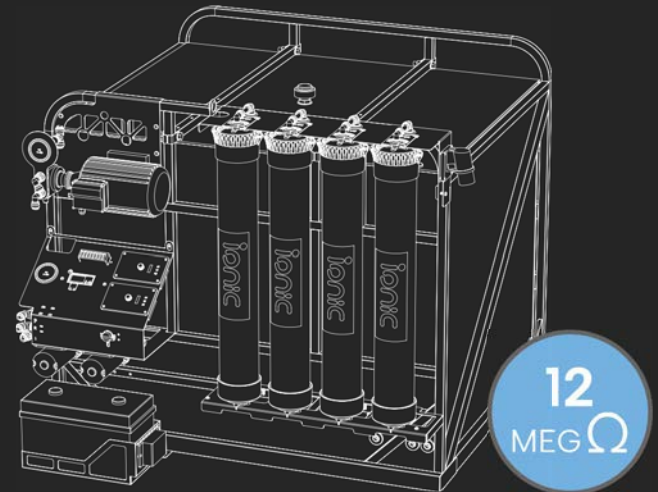

Learn more about
MegOhm on our
website!

Dimensions (mm):

300L & 400L = H 1065 x W 1129 x D 880

500L, 600L, 700L = H 1065 x W 1224 x D 1110

800L, 900L, 1000L = H 1065 x W 1224 x D 1260

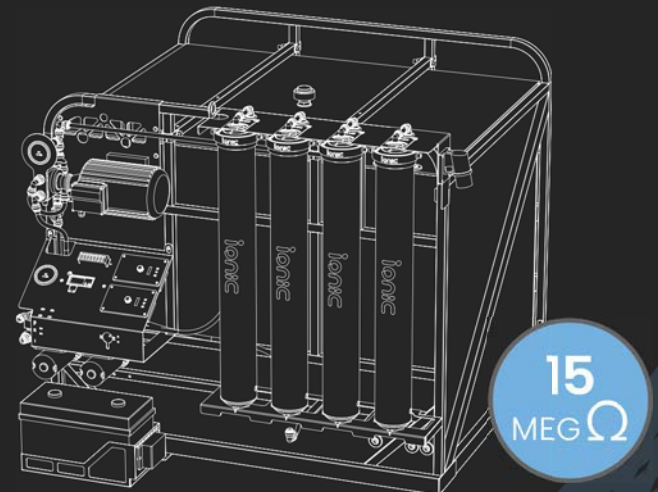

Dimensions (mm):

300L & 400L = H 1065 x W 1129 x D 880

500L, 600L, 700L = H 1065 x W 1224 x D 1110

800L, 900L, 1000L = H 1065 x W 1224 x D 1260



V4 Thermopure™

The industry leading large capacity filters used on the V4 Thermopure™ ensure the highest quality pure water filtration, combined with ease of maintenance and low running costs. With the addition of Ionic's 9kw diesel powered pure water heating system the V4 Thermopure™ becomes a powerful 4-season window cleaning system, busting stubborn dirt all year round. All the features of the Fusion model, but with the integrated extension of hot water.

Prices & Finance

	Machine Only	3-Year Finance	5-Year Finance
V4™ Thermopure 500 Litre	£11,600	£418	£278
V4™ Thermopure 600 Litre	£11,700	£418	£279
V4™ Thermopure 700 Litre	£11,800	£425	£283
V4™ Thermopure 800 Litre	£12,100	£436	£290
V4™ Thermopure 900 Litre	£12,200	£439	£293
V4™ Thermopure 1,000 Litre	£12,300	£443	£295

Finance prices are Per Calendar Month



12
MEGΩ

Dimensions (mm):

500L, 600L, 700L = H 1065 x W 1224 x D 1290
800L, 900L, 1000L = H 1065 x W 1224 x D 1440

V4 Thermopure™ 'S'

All the features of the standard V4 Thermopure™ model, with the added benefit of stainless steel filter housings. The 'S' model is highly recommend for use in countries where summer temperatures rise above 35 degrees C.

Prices & Finance

	Machine Only	3-Year Finance	5-Year Finance
V4™ Thermopure 500 Litre	£12,400	£446	£298
V4™ Thermopure 600 Litre	£12,500	£450	£300
V4™ Thermopure 700 Litre	£12,600	£454	£302
V4™ Thermopure 800 Litre	£12,900	£464	£310
V4™ Thermopure 900 Litre	£13,000	£468	£312
V4™ Thermopure 1,000 Litre	£13,100	£472	£314

Finance prices are Per Calendar Month



15
MEGΩ

Dimensions (mm):

500L, 600L, 700L = H 1065 x W 1224 x D 1290
800L, 900L, 1000L = H 1065 x W 1224 x D 1440

STATIC SYSTEMS

We offer static pure water systems combined with our bestselling Zero© & V4© window cleaning machines. These systems work in the exact same way as a vehicle mounted system, just fixed to one location.

For the cost of one system, you can supply several fleet vehicles with pure water at either OPPM or OPPB.

PPB
ZERO



Polypropylene Tank

Robust black plastic polypropylene tank will inhibit the growth of algae. Available in multiple sizes.

Control Panels

The control panels look and function exactly the same as our vehicle mounted systems. Complete with all automation features.

Ionic Refillable Filters

Ionic filters using either stainless steel or polymer housings.

V4



Prices & Finance

	Machine Only	3-Year Finance	5-Year Finance
Zero	£8,900	£320	£214
Zero S	£9,300	£335	£224
V4 Fusion	£5,100	£184	£122
V4 Fusion S	£5,900	£213	£142

Finance prices are Per Calendar Month

Zero™
Dimensions (mm):
H 1065 x W 1224 x D 420

V4™
Dimensions (mm):
H 1065 x W 1224 x D 330



Scan the QR Code for more information!

DELIVERY SYSTEMS

Stored pure water is then transferred into the tank of a “delivery system” which is installed in a van or trailer. Delivery systems are designed just to ‘deliver’ the pure water, i.e. they have little or no water treatment on-board, but have the same crash tested chassis and control gear as our other systems.

The Thermopure™ delivery system can heat the water using a diesel burner before pumping it to the pole, and is our most popular delivery option.



Polypropylene Tank

Robust black plastic polypropylene tanks available in multiple sizes, fit for your businesses needs.

Digital Flow Controls

Auto-compensating digital flow controls allows precise operation of the pumps.

FMVSS-208 Compliant

All Ionic vehicle mounted machines are fully crash tested to the FMVSS-208 standard.

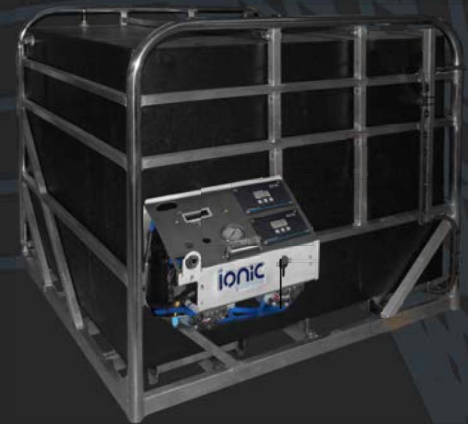

Thermopure™ Delivery Systems	Machine Only	3-Year Finance	5-Year Finance
Hot Delivery 500 Litre	£8,700	£314	£209
Hot Delivery 600 Litre	£8,800	£317	£212
Hot Delivery 700 Litre	£8,900	£321	£214
Hot Delivery 800 Litre	£9,000	£324	£216
Hot Delivery 900 Litre	£9,100	£328	£219
Hot Delivery 1,000 Litre	£9,200	£332	£221

Finance prices are Per Calendar Month

Thermo Delivery

Dimensions (mm):

500L, 600L & 700L =

H 1080 x W 1224 x D 1080

800L, 900 & 1000L =

H 1080 x W 1224 x D 1330

Cold Water Delivery Systems	Machine Only	3-Year Finance	5-Year Finance
Cold Delivery 300 Litre	£2,400	£87	£58
Cold Delivery 400 Litre	£2,500	£90	£60
Cold Delivery 500 Litre	£2,800	£101	£68
Cold Delivery 600 Litre	£3,200	£116	£77
Cold Delivery 700 Litre	£3,300	£119	£80
Cold Delivery 800 Litre	£3,600	£130	£87
Cold Delivery 900 Litre	£3,700	£134	£89
Cold Delivery 1,000 Litre	£3,800	£137	£92

Finance prices are Per Calendar Month

Cold Delivery

Dimensions (mm):

300L & 400L =

H 1065 x W 1129 x D 880

500L, 600L & 700L =

H 1065 x W 1224 x D 1065

800L, 900 & 1000L =

H 1065 x W 1224 x D 1260

PORTABLE SYSTEMS

Robust on demand systems perfect for an on site maintenance team with access to water and power.

Ionic Systems offer on site solutions using the same Reach & Wash® style of system. They are powerful enough to deliver pure water to up to two waterfed poles, so that multiple operators can clean at the same time. Portable systems require a water and mains power supply, and its boosted pump provides enough power for a steady supply of water up to 80ft in height.

Portable systems are ideal for a range of applications where access is limited, including courtyards, rooftop and atrium cleaning, as well as use in combination with cradles and rope access.

Our range of portable systems are a compact yet powerful point of use system, capable of producing up to 6 litres of pure water per minute, bringing the benefits of spot free cleaning to a wide range of applications.

Utilising the same water purification technology found in our vehicle mounted and static systems, our portable window cleaning range packs a serious punch!

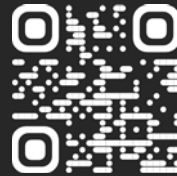

**Scan the QR Code for
more information!**



On site building maintenance teams use Ionic portable systems for in house window and façade cleaning duties as well as spot free car washing.

Lightweight and easy to transport, our portable range can be taken almost anywhere making it a truly flexible and versatile system with many uses. Our portable systems are also widely popular amongst high level abseiling crews.

QUATTRO™

Quattro™ is the perfect solution for sites where there is access to a water and power supply.

4-Stage Filtration



Deionisation



Reverse Osmosis



5-Micron Filtration



Carbon Filter



The Quattro™ – is available in three configurations. The standard Quattro works from water pressure alone (min 60psi), and is suitable for a single operator to use at lower levels.

The Quattro™ Electric – uses a 240V (or 110V) pump to boost the water pressure, and can be used to clean to 80ft for a single operator, or lower heights for multiple operators.

The Quattro 'S' – All the features and benefits of the Quattro Electric system, but with stainless steel filter housings. This allows for 2 operators to work from this one unit at a time.

Prices & Finance	Price	3-Yr Finance
Quattro™ System	£1,750	£63 pcm
Quattro™ Electric System	£3,000	£108 pcm
Quattro-S™ Electric System	£3,900	£141 pcm

TRION

Advanced Three-stage filtration for sites with water and power access.

Incorporating a powerful 240V (or 110V) mains electric pump, Trion™ can supply pure water to multiple waterfed poles even when water pressure is relatively low.

Trion™ incorporates a highly efficient 40" reverse osmosis membrane, as well as Deionisation and Carbon filters. It's capable of producing pure water economically, even when the local water is hard.

Mains powered pump

A powerful mains powered pump enables an excellent production rate

Manual flush valve

For RO Flushing.

Pneumatic tyres

Robust pneumatic tyres for ease of transport.

High Pressure Stainless Steel Housing

The Trion™ has a stainless RO housing to enable an even better production rate.

3-Stage Filtration



Deionisation



Reverse Osmosis



Carbon Filter



Prices & Finance

Trion™ System

Price

£2,250

3-Yr Finance

£81 pcm

TDS Meter upgrade

£100

ADDITIONAL EQUIPMENT



Dimensions (mm):
H 610 x W 610 x D 420

HotBox™

The HotBox™ uses the same diesel burners as our Thermopure™ Systems, and are capable of hot water within minutes of activation. The HotBox™ is powerful enough to provide piping hot water all year round. Includes 100Ah leisure battery and 15Ah mains charger.

Ordering & Prices	Price	3-Yr Finance
Hotbox 9 kW	£4,750	£171 pcm



Caddy™ DI System

The Caddy™ is a straight forward system that allows waterfed cleaning wherever there is access to a water supply. There are several Caddy™ configurations, from those that use only deionisation (eg. for soft-water areas).

Ordering & Prices	Price
Single DI	£275
Twin DI	£500
Triple DI	£650



TASK™

The Task™ Trolley is perfect for cleaning tasks in areas that have no access to water or hoses such as courtyards, or where trailing hoses cannot be used. The Task™ is also extremely useful for areas with restricted parking such as residential properties, busy high streets, city centres, etc. Includes 22Ah battery and 4Ah mains charger. 4hrs working time before recharge. 20-60 minutes working time (based on full tank).

Ordering & Prices	Price	3-Yr Finance
Task 75-Litre Trolley	£2,150	£78 pcm

Caddy™ In-Line Water Softener Kit

Ionic Systems in-line Caddy™ water softeners are the ideal choice for window cleaners on the move, made for water softening onsite. The portable Caddy™ is easily carried and connects in-line between the water supply and the machine. Softening water using an Ionic water softener is straightforward. Simply attach the in-line softener between the water supply and the machine, the softener will treat the water as it's used. Ionic offers a range of in-line softeners to suit all applications. Using the correct water softener will greatly improve performance and lifespan of the Reverse Osmosis filter. Includes flushing kit.



Ordering & Prices	Price
Caddy™ In-Line Softener Kit	£260
Caddy™ Duplex In-Line Softener Kit	£520
Caddy™ Triple In-Line Softener Kit	£670

WallSoft™ In-line Water Softener Kit

A simple wall mounted water softener system that connects in-line between the water supply and the machine. Installed at the primary place of pure water production, WallSoft™ can be configured to soften even the hardest water.



Ordering & Prices	Price
WallSoft Softener Kit	£250
Twin WallSoft Softener Kit	£450

FOAMION

Built for Soft Washing professionals. The Foamion™ provides the highest quality cleaning, mixed with ultimate efficiency and usability.

Foamion™ is a cost effective add on, foaming Soft Wash machine, and it works in conjunction with your existing Reach & Wash® System. Foamion™ gives the operative the option to mix any chemical product, i.e. Sodium Hypochlorite or Biocides at the point of use. This is a perfect way to apply treatments for algae infestations on render, plastics, or other external surfaces. Foamion™ can also be used to treat moss on roof tiles, or apply black spot remover for patios, paths, or driveways.

Using either hot or cold water (depending on the system it's fitted to), the on board air compressor gives the benefit of creating foam, allowing better chemical contact time and easier application. It has high and low chemical injector settings depending on the job at hand.

It holds 1 x 25L chemical drum, plus 2 x 5L chemicals of your choice. Max chemical mix 3/1, minimum 19/1.

In regards to Soft Washing, the Ionic ethos is about placing the integrity of the surface first. We manufacture products capable of maximising the efficiency of the chemicals being used.

This allows the operator to use the minimum amount of chemicals to achieve excellent results, whilst protecting your pocket and the environment!

Our sister company, the BWCA, teaches that:

“You can always add more, but you can't take away!”

Thus, our customers can achieve high quality finishes whilst protecting the surface, and importantly, the environment from high chemical concentrations, whilst being efficient in their work.

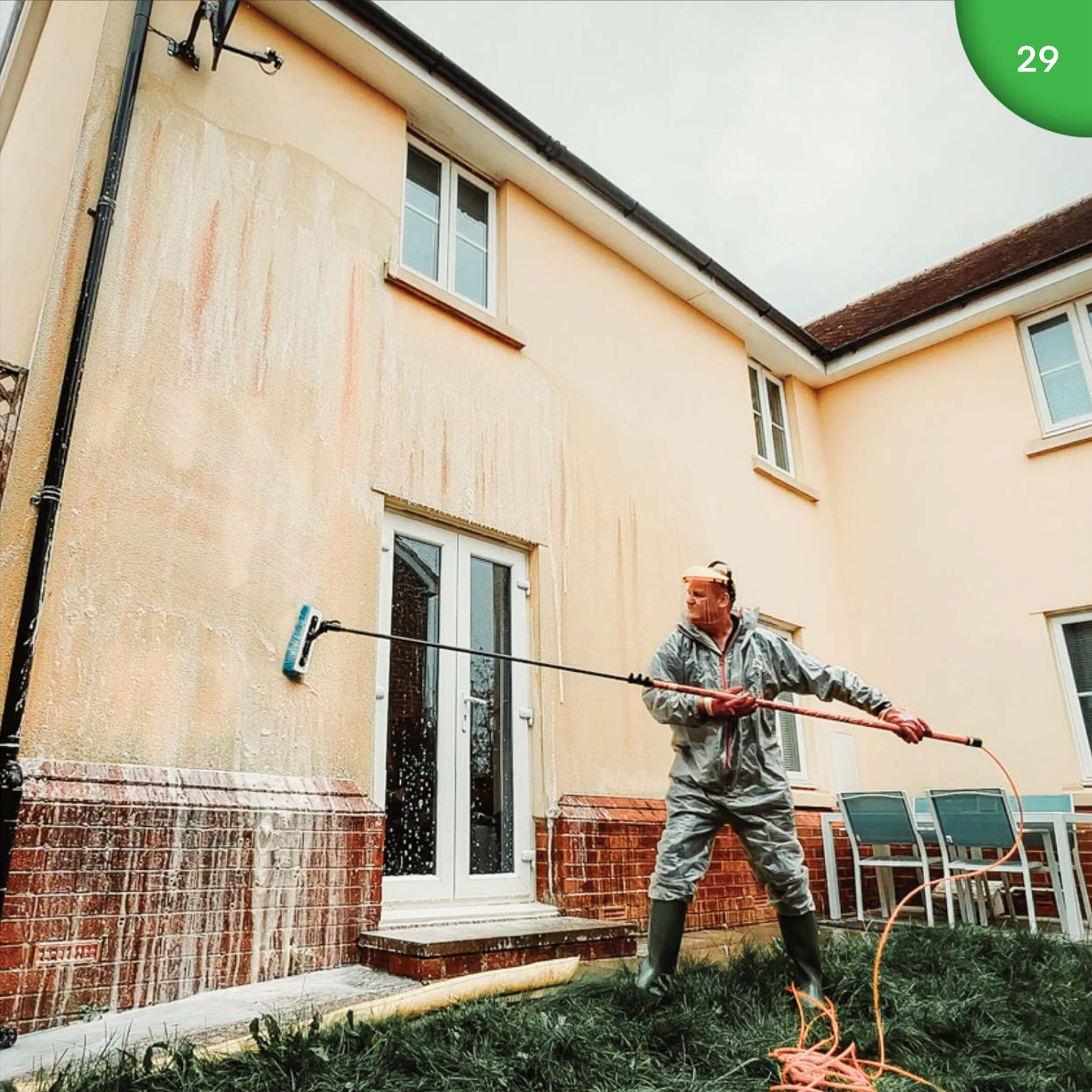



Foamion™ Vehicle Mounted System

Prices & Finance

Foamion™	Machine Only	3-Year Finance	5-Year Finance
Foamion™ with 2x 150Ah Lead Acid Batteries & Charger	£4,500	£162	£108
Foamion™ with 2 x 100Ah Lithium Ion Batteries & Charger	£6,000	£216	£144

Finance prices are Per Calendar Month



Scan the QR Code for more information!



Constant Flow™ Foam Cleaning Package

Powerful, heavy duty foam cleaner for effective removal of algae. Constant Flow system used with Contact Foam cleaner produces a stable foam which rinses freely. Can be used with hot or cold water. The spray nozzle attaches to the Vertigo™ Quick Release waterfed pole head assembly.

Ordering & Prices

	Price
Constant Flow Package - 24ft Hydra CF	£825
Constant Flow Package - 28ft Hydra CF	£875
Constant Flow Package - 32ft Hydra CF	£931
Ionic Contact 5L	£36
Ionic Contact 25L	£95



Foamion™ Portable

Introducing the all new portable version of the Foamion™!

The Foamion's advanced lithium battery technology provides long lasting power, making it a reliable tool for cleaning professionals. Its new compact design makes it easy to store and transport, and its versatility allows it to be used as a stand alone unit or mounted to an existing Reach & Wash™ system. The fact that it can be used by those without an Ionic Reach & Wash™ system is also a great advantage.

The Foamion™ works by combining preferably pure water, chemical, and air to create a foam that sticks to surfaces and provides extended dwell time. This means that the cleaning solution stays on the surface longer, allowing it to work more effectively. Additionally, the foam reduces the amount of overspray, which minimises the amount of cleaning solution wasted.

The Foamion™ is an excellent tool for a wide range of cleaning applications, including cleaning windows, vehicles, and building exteriors. Its ability to provide a controlled fusion of water, chemical, and air makes it a versatile and effective cleaning solution.

Prices & Finance

Foamion™ Portable	Machine	3-Year Finance	5-Year Finance
Foamion™ Portable w/ 100Ah Lithium Battery (15A Charger)	£3,700	£133	£89
Foamion™ Portable Stainless Steel Trolley	£400		

Finance prices are Per Calendar Month

Launched
2023!



Stainless Steel Trolley

Removable 'sack truck' style trolley is made of the same high quality, non-corroding stainless steel seen on all of our systems.

Easily manoeuvrable

System can be stored in your vehicle. Simply slide the system out from its trolley and place in the desired position within your vehicle.

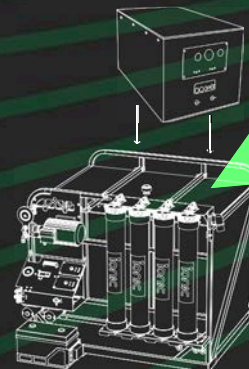

Removable

Unit can be securely attached to the stainless steel frame of an existing Reach & Wash™ system.





"A system that is environmentally friendly and can be used in all types of weather. Patented technology that dispels any doubts that using just water is the most safe and effective way to clean a roof."

Revolution, Practicality & Simplicity

Until now, roof cleaning has always been a job that presents many challenges. Costly forms of safe access through the use of hired scaffolding or powered access are a significant barrier to a sustainable and profitable business model. Once access has been gained, multiple cleaning techniques requiring additional equipment are required to produce instant and lasting results.

Roof Wand™ offers an all-in-one, safe alternative to pre-existing methods of roof cleaning. Delivering quality service from the safety of the ground is now possible with this revolutionary new equipment. With Roof Wand™, it is now possible to offer customers a complete house cleaning package, without the need for costly access methods.

We have developed the Mast Trolley to

provide a sturdy yet highly manoeuvrable support base for roof cleaning. Mast height reaches 6 metres, with an additional 70cm of adjustable reach. The stainless steel frame provides a solid and lasting structure for the 70L water tank, which when fitted with the optional 5LPM pump can be filled with pure water and used to effectively clean windows after the roof cleaning process.

The mast itself is made of lightweight & ultra durable Carbon Fibre.

X and Y axis actuators allows for instantaneous horizontal and vertical movement up to 30°, controlled via remote control. Radio control of this movement enables the operator to work continuously without the need to move the Mast Trolley.

More time cleaning equals more income!

21 Litres Per Minute

This method uses high volumes of water, rather than high pressure to clean roofs.

2/3 Turbo Nozzles

Choose between splitting 21LPM water over 2 or 3 Turbo Nozzles.

Flexible nozzle covers

High quality silicone covers act as shock absorbers in the event of impact with the roof.

Remote Control

Operate the vertical and horizontal movement of the mast using a handheld remote control. Controls are also located on the mast itself.



High Manoeuvrability

Mast Trolley can easily be transported from van to site.



Horizontal movement

30° of movement through use of a remote control, the mast can easily move to follow the wand across any roof.

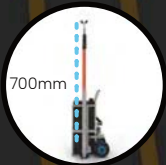

Vertical movement

700mm of movement through use of a remote control. Allows for additional fine adjustment of mast head position, after manually setting telescopic pole height.

High Quality Carbon Fibre

Ultra-lightweight carbon fibre allows easy and efficient use of the cleaning wand.

18 Metres Reach

Wand consists of 9 poles – 3 adjustable telescopic Glass Fibre poles, with protective non-conducting insulation. 7 quick release Carbon Fibre pole sections (2m each). Total possible length of 18m.

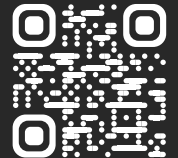

Scan the QR Code for more information!

Basic

Perfect for businesses with an existing window cleaning system looking to expand their services.

£195

Monthly

Prices based on 5 year (60 month) finance package.

CF Wand Assembly

Mast Trolley
(without Pump)

Brushes + Hoses

Total Price
£8,100

Standard

Ideal for roof cleaning professionals who already own a compatible pressure washer.

£210

Monthly

Prices based on 5 year (60 month) finance package.

CF Wand Assembly

Mast Trolley (with
Pump)

Brushes + Hoses

Total Price
£8,600

Premium

Built for professionals looking for a complete exterior cleaning system.

£260

Monthly

Prices based on 5 year (60 month) finance package.

CF Wand Assembly

Mast Trolley (with
Pump)

Brushes + Hoses

Pressure Washer
(Key Start)

Total Price
£10,750



Mast Trolley Specifications

Pressure	6.9 bar (100 psi)
Flow	5 LPM (open flow)
Battery	12V, 22Ah (lead acid)
Wheels	Pneumatic
Actuators	12V
Dimensions	615D x 530W x 1100H
Weight	37kg (Dry), 107kg (Wet)

Pressure Washer Specifications

Pressure	200 bar (2900 psi)
Flow	21 LPM
Engine	Honda GX390 (with oil alert)
Starter	Electric & recoil
Fuel Capacity	6.1 Litres
Dimensions	800L x 640W x 840H
Weight	66.5kg

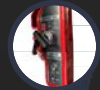

HYDRA™

Lightweight. Adaptive. Versatile.

When you pick up the new Hydra™ pole the first thing you notice is just how light it is. Ionic has really focused on weight reduction and have reduced the wall thickness of every pole section, resulting in significant weight savings, and maintained rigidity. Narrower handles provide a more comfortable grip. With all this in mind, cleaning windows at height has never been easier.

Patented spring loaded clamps.

Spring assisted clamps that we believe to be the only true 'anti-rotational' clamps on the market. These clamps have been designed with reducing wear on the pole in mind, whilst simultaneously extending the pole's useable lifespan.

Protector™ Electrical Insulation.

The Hydra™ waterfed pole now comes with electrical insulation as standard on all poles. We saw too many stories of window cleaners being electrocuted by overhead power cables whilst on the job. So, we decided to introduce an insulated coating to all our waterfed poles. BS:8020 is the specification for insulating hand tools for work on or near conductor rail systems operating at voltages up to 1000 V a.c. or 1500 V d.c.



**Scan the QR Code to
watch a video on
electrical pole safety!**



Reach new heights.

With a maximum reach of up to 80ft, Ionic Hydra™ waterfed poles will allow you to safely reach and wash most exterior windows and surfaces before you will need further assistance. You may think that all that extra pole will become cumbersome and hard to use – that is simply not the case. Our longest pole only weighs 8kg, providing you with the light touch necessary for daily professional work.





10ft 7 Poles 80ft

7ft 3 Poles

45ft
55ft
65ft

6ft 3 Poles

35ft
40ft
45ft

5ft Poles

17ft
21ft
24ft
28ft
32ft

Grafter.



Non-curling monofilament nylon bristle brush and adjustable angle crank design.

Primarily suited for residential cleaning.



Swift.



Extremely robust aluminium build, designed for commercial cleaning.

Available with varying Gooseneck lengths for different size sills.

9" 24" 36"

Available with 14" & 18" brushes. Also available as flocked brush.

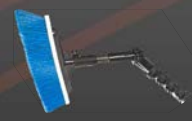

Primarily suited for commercial cleaning.



Vertigo.



Tubeless angle crank design. Comes with either standard fitting or quick release brush head. Quick Release Brush heads are available with three sizes of necks.



6"
9"
15"

Also available with blue flocked brush head for soft washing and microfibre pads.

Pencil Jets

Fan Jets

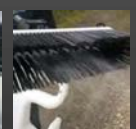
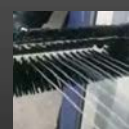

Suited for both residential and commercial cleaning.



PRICES AND WEIGHTS

All prices include flyleads.

HYDRA™

	Pole Only**	Grafter™ Head	Swift™ Head	Vertigo™ Standard Head	Vertigo™ Quick Release Head	Weights		
						Pole Only	Pole inc lightest brush/head	
	MiniPole (2 sections)	£ 91				600g	1kg	
GLASS FIBRE	Hydra GF 17/5	£ 115	£ 172	£ 212	£ 196	£ 231	1.29kg	912g
	Hydra GF 21/5	£ 130	£ 187	£ 227	£ 211	£ 246	1.22kg	1.60kg
	Hydra GF 24/5	£ 150	£ 210	£ 250	£ 234	£ 269	1.55kg	1.93kg
	Hydra GF 28/5	£ 175	£ 235	£ 275	£ 259	£ 294	1.90kg	2.28kg
	Hydra GF 32/5	£ 200	£ 266	£ 306	£ 290	£ 325	2.29kg	2.67kg
	Hydra CF21/5.2	£ 210	£ 267	£ 307	£ 291	£ 326	984g	1.36kg
	Hydra CF 24/5.2	£ 260	£ 320	£ 360	£ 344	£ 379	1.23kg	1.61kg
	Hydra CF 28/5.2	£ 310	£ 370	£ 410	£ 394	£ 429	1.46kg	1.85kg
	Hydra CF 32/5.2	£ 360	£ 426	£ 466	£ 450	£ 478	1.73kg	2.11kg
	Hydra CF 35/6.3	£ 370	£ 436	£ 476	£ 460	£ 495	1.79kg	2.17kg
CARBON FIBRE	Hydra CFP 35/6.3	£ 600	£ 666	£ 706	£ 690	£ 725	1.79kg	2.17kg
	Hydra CF 40/6.3	£ 410	£ 476	£ 516	£ 500	£ 535	2.10kg	2.48kg
	Hydra CFP 40/6.3	£ 750	£ 816	£ 856	£ 840	£ 875	2.10kg	2.48kg
	Hydra CF 45/6.3	£ 510	£ 576	£ 616	£ 600	£ 635	2.46kg	2.84kg
	Hydra CFP 45/6.3	£ 900	£ 966	£ 1,015	£ 990	£ 1,025	2.46kg	2.84kg
	Hydra CF 45/7.3	£ 560	£ 626	£ 666	£ 650	£ 685	2.88kg	3.26kg
	Hydra CFP 45/7.3	£ 1050	£ 1,116	£ 1,156	£ 1,140	£ 1,175	2.88kg	3.26kg
	Hydra CF 55/7.3	£ 775	£ 847	£ 887	£ 871	£ 906	3.93kg	4.31kg
	Hydra CFP 55/7.3	£ 1500	£ 1,572	£ 1,612	£ 1,596	£ 1,631	3.93kg	4.31kg
	Hydra CF 65/7.3	£ 1050	£ 1,122	£ 1,162	£ 1,146	£ 1,181	5.02kg	5.41kg
Hydra CFP 65/7.3	£ 1850	£ 1,922	£ 1,962	£ 1,946	£ 1,981	5.02kg	5.41kg	
Hydra CFP 80/10.7	£ 3000	£ 3,076	£ 3,116	£ 3,100	£ 3,135	7.97kg	8.49kg	

*Hydra CFP models have even greater rigidity carbon fibre

**Flyleads no included

HYDRA™
CF45/7.3

CF
Carbon
Fibre

45
ft
Extended
Length

7.3
ft
Collapsed
Length

ENDURA

Unique anti-rotational technology. We have achieved the world's first true anti-rotational waterfed pole with Protector™ handle, without compromising on the strength & integrity of the classic circular design.

NEW to
2024!

Unique Anti-rotational design

In 2016, Ionic Systems embarked upon designing & manufacturing an anti-rotational waterfed pole. We have spent years researching and developing a waterfed pole clamping system that can withstand & reduce wear of the tubes over time and still not rotate/spin, even when worn. This is a problem universal to all modern window cleaners using the waterfed pole method. However, we endeavoured to create a waterfed pole designed not to spin and built to last.

In 2018, we had a patent granted for an anti-rotational pole. This early design was a 'teardrop' shape, as seen in the image below. However, we decided not to bring this pole to the market as it compromised the overall rigidity of the pole and the tubes were still able to rotate a small amount. Therefore, this was not a true anti-rotational pole and did not meet our standards. Not all innovation makes it to the production line. Quality without Compromise.



FEATURES

Unique anti-spin technology equipped with 1000v electrical insulation handle section as standard. New design bolted on clamps.

Brushes

The Endura pole is compatible with all our current range of brushes. See below or find more information on our website.



Grafter™

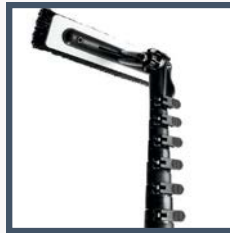

Vertigo™
Standard Head



Vertigo™
Quick Release



Swift™

Prices & Ordering

Prices include flyleads (10m, 16m & 22m)*. Choice of brush heads sold separately. Vertigo™ brush heads available with pencil jets or fan jets, in the commercial or lightweight design.

Pole Size	Pole Only*	Grafter™	Vertigo™ SH	Vertigo™ QR	Swift™ w/ 9" glossneck
Endura 24ft CF	£350	£410	£434 (14") £439 (18")	£469 (14") £474 (18")	£459 (14") £464 (18")
Endura 32ft CF	£500	£566	£590 (14") £595 (18")	£625 (14") £630 (18")	£615 (14") £620 (18")
Endura 45ft CF	£650	£716	£740 (14") £745 (18")	£775 (14") £780 (18")	£765 (14") £770 (18")
Endura 55ft CF	£850	£922	£946 (14") £951 (18")	£981 (14") £986 (18")	£971 (14") £976 (18")

*Excluding fly lead

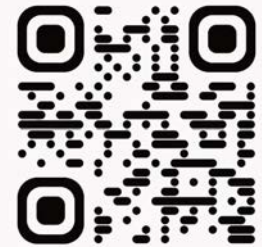

Follow the QR code above to view more information on our website.

ionicsystems.com

HOSE REELS



Rapido™ Electric Hose Reel

Stackable 12v Electric Hose Reel with push button operation for super easy reeling. A second Rapido can be easily stacked on top.

Ordering & Prices	Price
Electric Hose Reel	£750

Fitting is free as part of a system install, and £65 if a standalone install. Available with 6mm & 8mm hoesails. £8 each.



½ inch Hi-Vis Hose

12.5MMHS

£3 per Meter



6mm RX Hose (100m)

RX6100

£80



8mm RX Hose (100m)

RXH100

£100

Stainless Steel Hose Reel

Top quality stainless steel hose reel with wheels. Comes as Portable, Hand Carriable or Floor Mounted.

Available with 6mm, 8mm & 12mm hoesail. £8 each.



Hand Carriable Reel

£240

Holds 50m of ½ inch hose or 100m of Ionic RX Hose.

Stainless Hose Reel

£275

Holds 50m of ½ inch hose or 100m of Ionic RX Hose.

Floor Mounted Reel

£240

Can be double stacked using a stacking frame (£125) & 2nd reel.



GUTTER VACUUMS



Vortex™ Gutter Vacuum – Premium range

This powerful system has 50% more suction lift power than its nearest rival. Three industrial strength vacuum motors giving huge suction power of 150 inches of water lift.

Kit Includes: Vortex Vacuum, flexi pick up hose (50mm diameter), Elite carbon fibre clamped poles, Crevice tool, soft daily tool for aluminium gutters, Dirt breaker, Tapered end tool narrow, Tapered end tool wide, Long reach tool, Pole and accessory carrying bag.

Pole options:	Price
4 Poles 20ft/6m Reach	£2,600
6 Poles 30ft/9m Reach	£2,830
8 Poles 40ft/12m Reach	£3,060

Camera Kit

Designed for real-time gutter clearance and high level inspection. Built with a 4.3" screen and sleek look, perfect for gutter cleaning professionals.

Options:	Price
Non-recordable system	£300
Recordable system	£480



Vortex piccolo™ Gutter Vacuum with Cyclonic Side Entry

Safe and easy gutter vacuuming with this wet and dry vacuum, ideal for domestic use, especially high reach applications. Now with cyclonic side entry vacuum. Available with push fit or clamped poles.

Push Fit Pole Kit Includes:

1x Vortex Piccolo (with 50mm Cyclonic Vac port), 44mm Standard Carbon Fibre Poles, NEW 5m x 50mm Wire reinforced suction hose, 4.5 Metres of 38mm standard flexi hose with 1 x Vac to port cuff / 1 x Hose to pole cuff for blow function, 1x Vac to Hose cuff 50-51mm /Hose to Pole 50-44 Cuff, 3 x tools: Crevice End /Standard Dirt Breaker /Daily End Tool, 2 x silicone neck tool holders: 135 & 180 Degree Blue flexi neck tool Holder, Floor tool kit & Carry bag.



Vortex™ Gutter Vacuum

Vacuum has two Industrial strength vacuum motors giving huge suction power of 100 inches of water lift.

Kit Includes: Vortex Vacuum, Poles, flexi pick up hose (50mm diameter), Crevice end tool, Steel dirt breaker, Tapered end tool, Daily end tool, Long end tool, 135 degree blue flexi neck tool holder, 180 degree blue flexi neck tool holder, Pole and accessory carrying bag. Choice of 3 height reaches.



Pole options:	Price
4 Poles 20ft/6m Reach	£1,810
6 Poles 30ft/9m Reach	£1,990
8 Poles 40ft/12m Reach	£2,170

Push-fit Pole options:	Price
4 Poles 20ft/6m Reach	£665
6 Poles 30ft/9m Reach	£775
7 Poles 34ft/10.5m Reach	£830

Clamped Pole options:	Price
4 Poles 20ft/6m Reach	£1,010
6 Poles 30ft/9m Reach	£1,200
7 Poles 34ft/10.5m Reach	£1,310



Quality. Safety. Efficiency.

Visit us on our Website!

Ionic Systems Ltd

7-8 Westerngate
Hillmead Enterprise Park
Swindon, Wiltshire
SN5 5WN

Telephone: (01793) 871386

Email: info@ionicsystems.com



Discover

more on our social media channels



www.ionicsystems.com

Copyright 2024, Ionic Systems Ltd. All finance examples are for information only. Terms & conditions apply. All prices exclude VAT unless otherwise indicated. E&OE – Errors & Omissions excepted.